

Write.

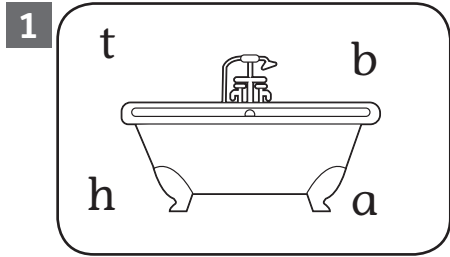

bath

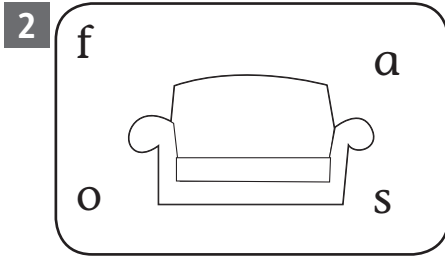

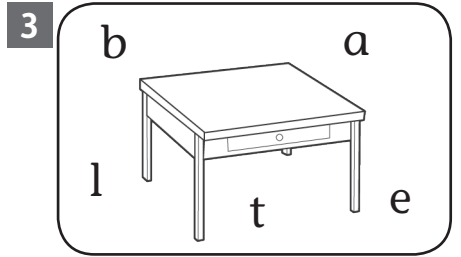

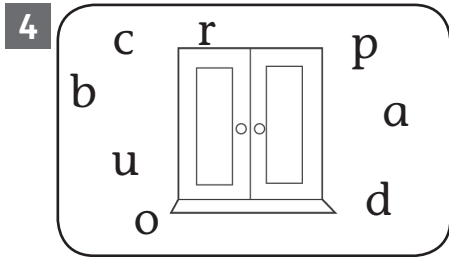

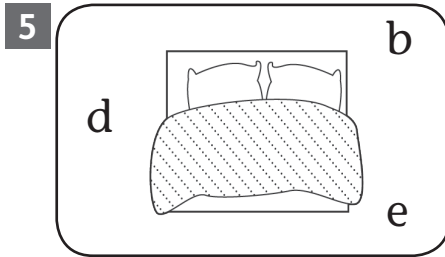

Look and write.

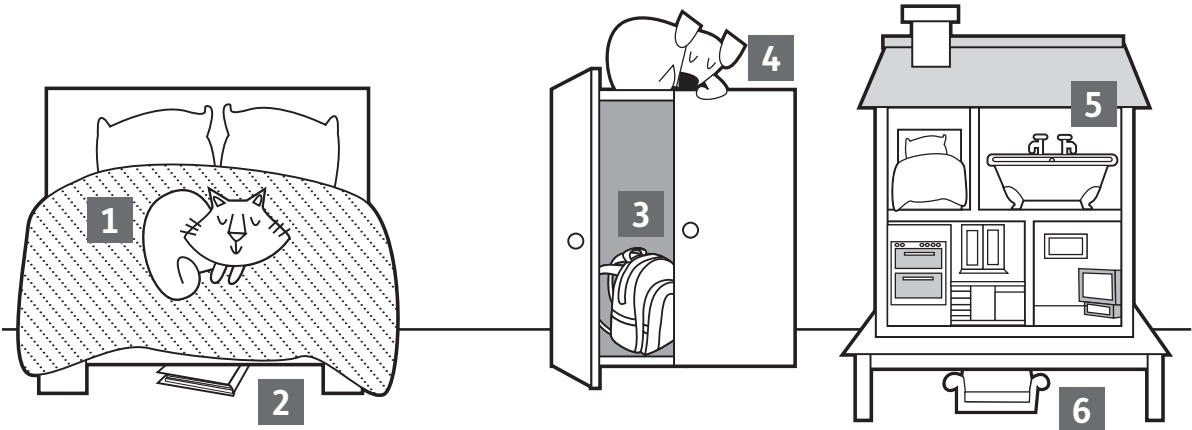

- 1 The cat is on the bed.
- 2 The book is under the _____.
- 3 The bag is in the _____.
- 4 The dog _____ the _____.
- 5 The _____ is _____ the _____.
- 6 _____

Write. Match.

a a a ay ea i ie ie o oo

- 1 pl ___ f ___ tb ___ ll
- 2 r ___ de a bik ___
- 3 cl i mb
- 4 r ___ d
- 5 wr ___ t ___
- 6 dr ___ w
- 7 c ___ tch
- 8 h ___ p

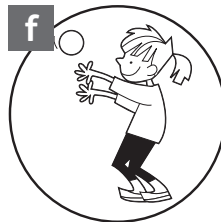
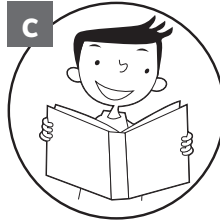
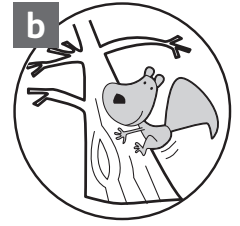

Look, circle and write.



He can / can't climb.

He can / can't _____.



She can / can't _____.

He _____.

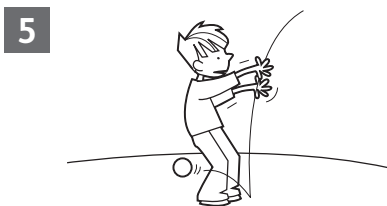

He _____.

She _____.

3

Look and write.

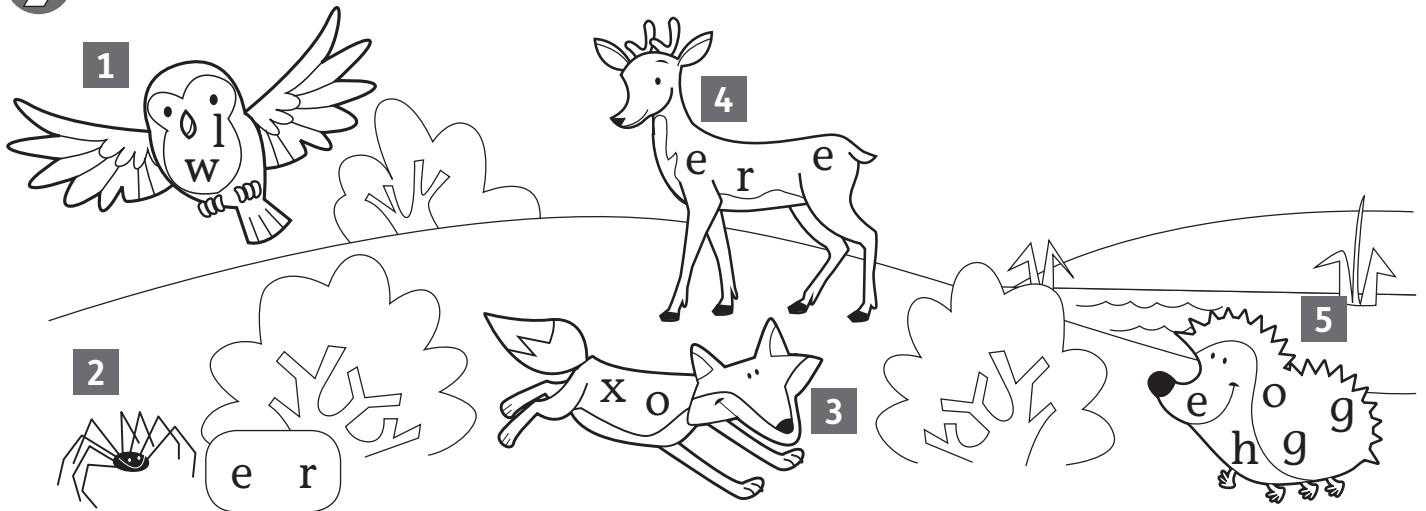

1 o w l

2 spid _ _

3 f _ _

4 d _ _ _

5 hed _ _ _ _

Look and write.

next to behind in front of

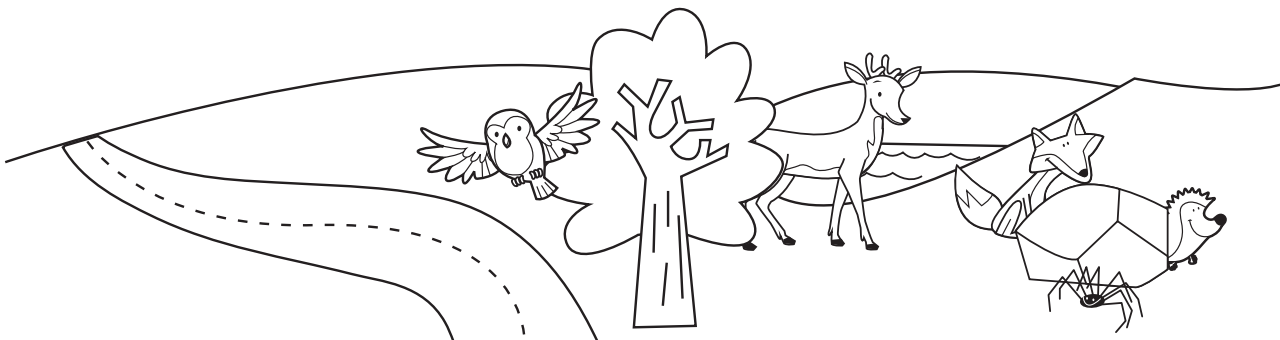

1 The fox is next to the deer.

2 The hedgehog is _____ the rock.

3 The deer is _____ the tree.

4 The owl is _____ the tree.

5 The spider is _____ the rock.

6 The fox is _____ the rock.

7 The owl is _____ the road.

8 The deer is _____ the lake.

Write. Find and circle.

a a

e e e e e e e e

o o o o



bl ___ nd hair



fr ___ ckl ___ s



l ___ ng hair



sh ___ rt hair

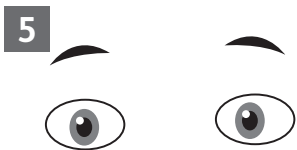

___ y ___ br ___ ws



blue ___ y ___ s



gl ___ ss ___ s



d ___ rk hair

| | | | | | | | | |
|---|---|---|---|---|---|---|---|---|
| w | n | w | a | e | y | e | s | e |
| s | l | e | h | e | g | y | c | d |
| f | r | e | c | k | l | e | s | c |
| l | o | n | g | x | a | b | h | v |
| q | s | u | e | d | s | r | o | s |
| m | g | u | n | a | s | o | r | p |
| u | l | o | t | r | e | w | t | n |
| y | l | w | e | k | s | s | m | e |
| b | m | s | s | u | t | g | j | t |

Write. Read, draw and colour.

1 She's got gl_____.

5 He's got fr_____.

2 She's got long _____.

6 He's got blond _____.

3 She's got d_____ hair.

7 He's got s_____ hair.

4 She's got blue _____.

8 He's got brown _____.

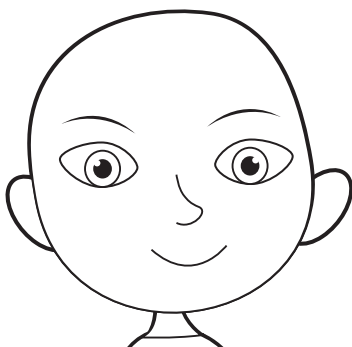

Sarah

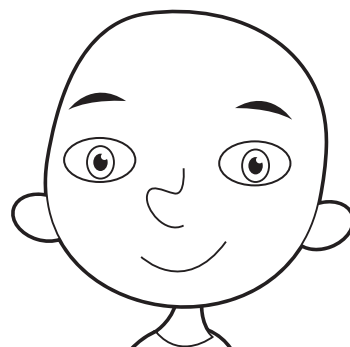

Paul